

Article number: 204040M16150A3U

Description: E+G levelling foot
GN 40-40-M16-150-A3-U

Note: U Without nut, Hexagon socket at the top, Wrench flat at the bottom

Measures

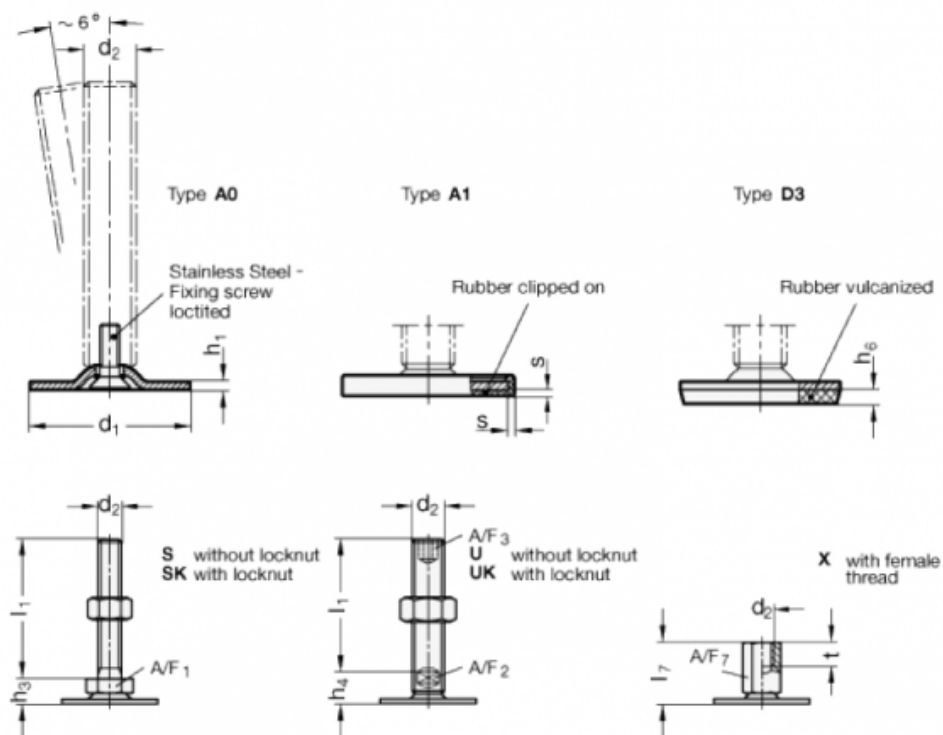

A/F2 = 12
A/F3 = 8
d1 = 40
d2 = M16
h1 = 2
h4 = 17
h6 = 3.5
l1 = 150

s =